

TX-B3A140-010G

PRODUCT SPECIFICATION

Approved by:

Checked by:

Prepared by:

Part No.	TX-B3A140-010G	Spec No.	WKF-BA3066	Page	1 of 9
-----------------	----------------	-----------------	------------	-------------	--------

Features:

- Excellent Transiting Heat from LED Chip Operating under 700mA
- High Luminous Output
- No UV

Typical purpose:

- Portable Flashlight
- Garden lighting
- General Lighting

Package Dimensions:

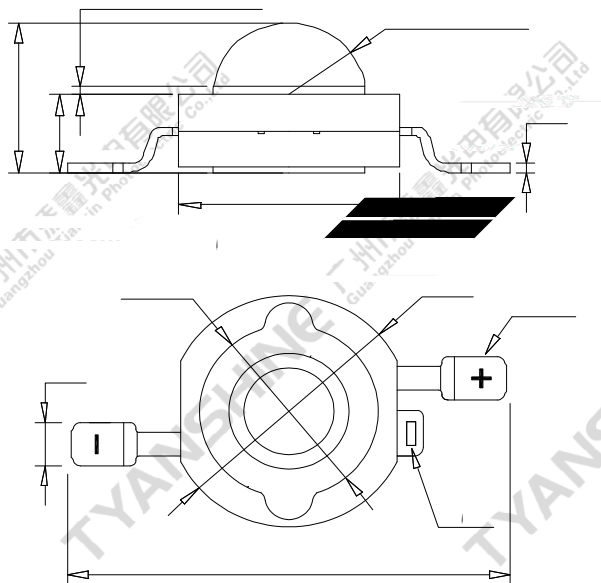

Installs on the aluminum sheet:

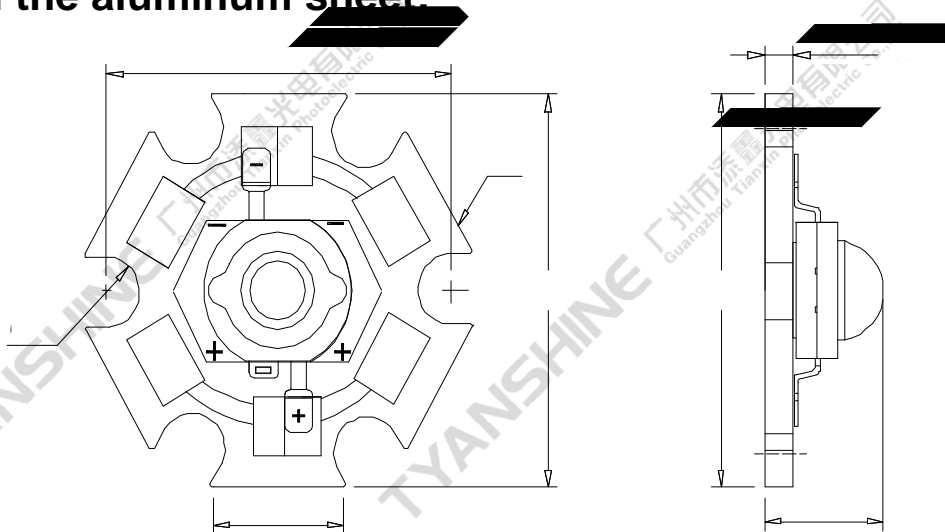

Part No.	TX-B3A140-010G	Spec No.	WKF-BA3066	Page	2 of 9
-----------------	----------------	-----------------	------------	-------------	--------

Notes:

1. All dimensions are in millimeters (inches).
2. Tolerance is ± 0.25 mm (0.01") unless otherwise noted.

Part NO.	Lens Color	Emitting Color
TX-B3A140-010	Water Clear	Blue

Absolute Maximum Ratings at Ta=25

Parameter	Symbol	MAX.	Unit
LED Junction Temperature	T _j	150	
Power Dissipation	P _D	2660	mW
Peak Forward Current (1/10 Duty Cycle, 0.1ms Pulse Width)	I _{FP}	1000	mA
Continuous Forward Current	I _F	700	mA
Reverse Voltage	V _R	5	V
Electrostatic Discharge Threshold (ESD) Operating	ESD	2000	V

Notes:

1. Specifications are subject to change without notice.
2. The data on this specification is for reference only and the actual data is in accordance with the acknowledgment.
3. Precautions for ESD:

STATIC SHIELD Electricity and surge damages the LED. It is recommended to use a wrist band or anti-electrostatic glove when handling the LED. All devices, equipment and machinery must be properly grounded.

TYANSHINE 广州市深鑫光电有限公司
Guangzhou Tianxin Photoelectric Co., Ltd.

TYANSHINE 广州市深鑫光电有限公司
Guangzhou Tianxin Photoelectric Co., Ltd.

TYANSHINE 广州市深鑫光电有限公司
Guangzhou Tianxin Photoelectric Co., Ltd.

TYANSHINE 广州市深鑫光电有限公司
Guangzhou Tianxin Photoelectric Co., Ltd.

TYANSHINE 广州市深鑫光电有限公司
Guangzhou Tianxin Photoelectric Co., Ltd.

TYANSHINE 广州市深鑫光电有限公司
Guangzhou Tianxin Photoelectric Co., Ltd.

TYANSHINE 广州市深鑫光电有限公司
Guangzhou Tianxin Photoelectric Co., Ltd.

Typical Electrical / Optical Characteristics Curves

(25 Ambient Temperature Unless Otherwise Noted)

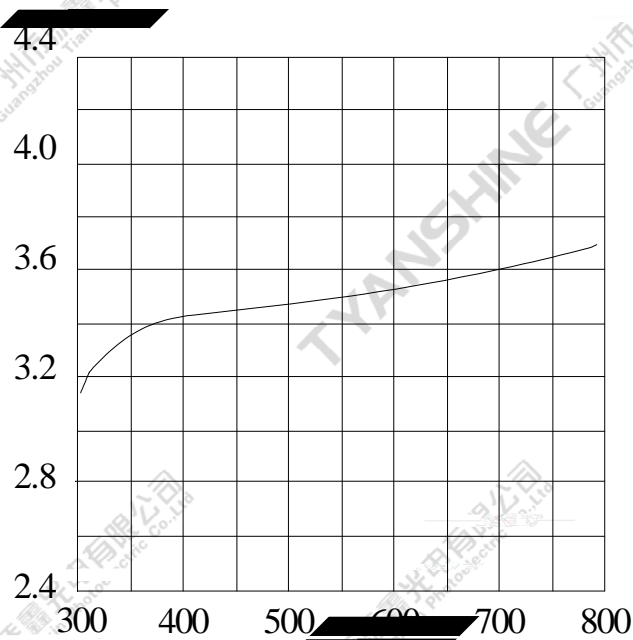

Forward Current VS.Luminous flux

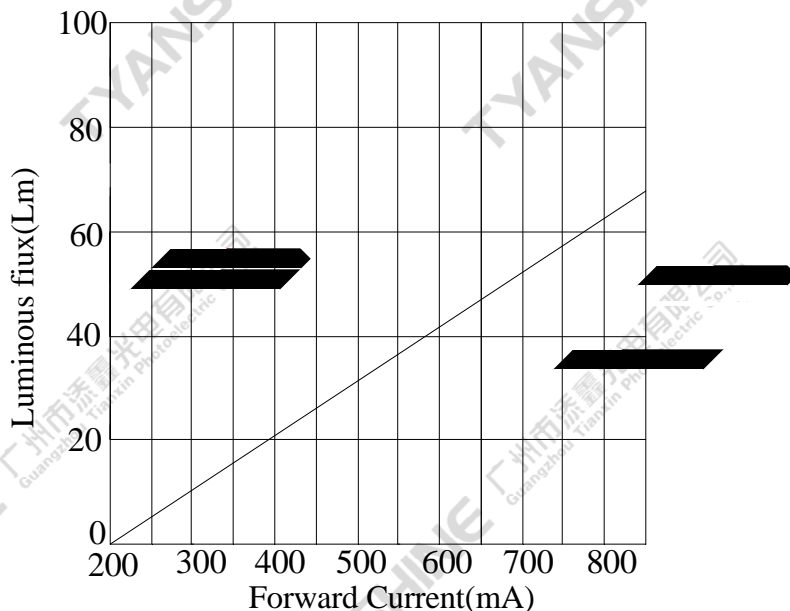

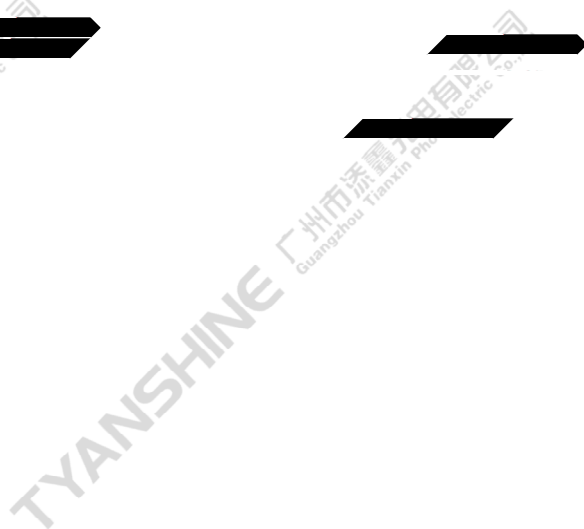
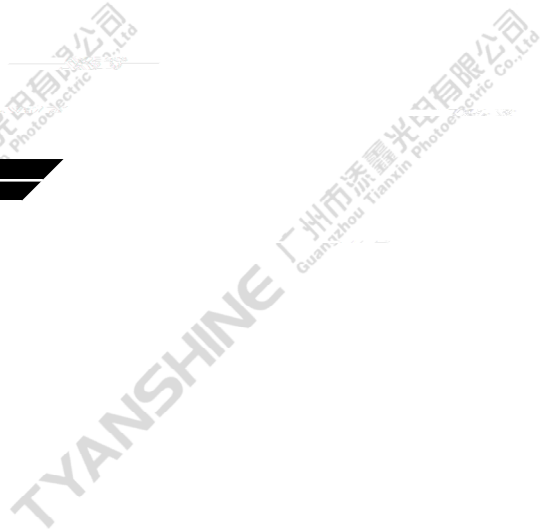
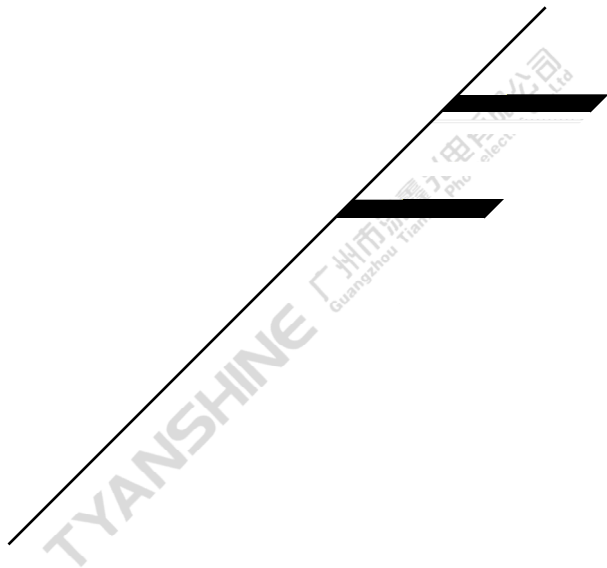

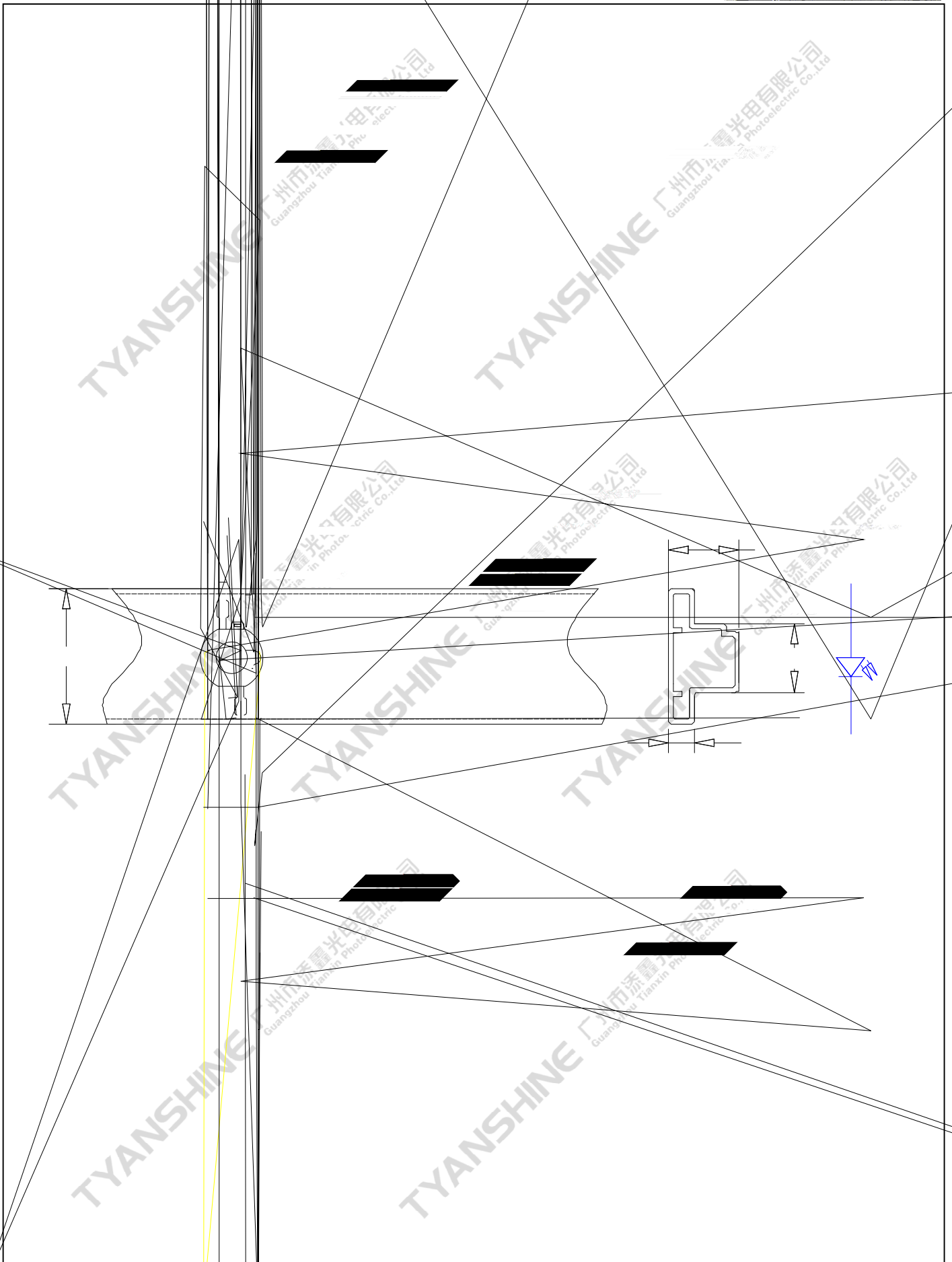

Part No.	TX-B3A140-010G	Spec No.	WKF-BA3066	Page	8 of 9
----------	----------------	----------	------------	------	--------

Notes:

- 1. All dimensions are in millimeters (inches).
- 2. Tolerance is ± 2.0 mm (0.08") unless otherwise noted.
- 3. Product is packaged with silicone to protect the light-emitting zone. Please avoid the light-emitting area from being pressed, stressed, rubbed, come into contact with sharp metal part which would damage the product.

Part No.	TX-B3A140-010G	Spec No.	WKF-BA3066	Page	9 of 9
-----------------	----------------	-----------------	------------	-------------	--------